



INTAKE SYSTEMS FOR VEHICLES LISTED ARE 50 STATE LEGAL. SEE KNFILTERS.COM FOR CARB STATUS ON EACH PART FOR A SPECIFIC VEHICLE.

INSTALLATION INSTRUCTIONS

77-3064KTK CHEVROLET / GMC 2006 CK4500 / CK5500 V8-6.6L DSL

NOTE: This kit was not designed to fit vehicles with a body lift.

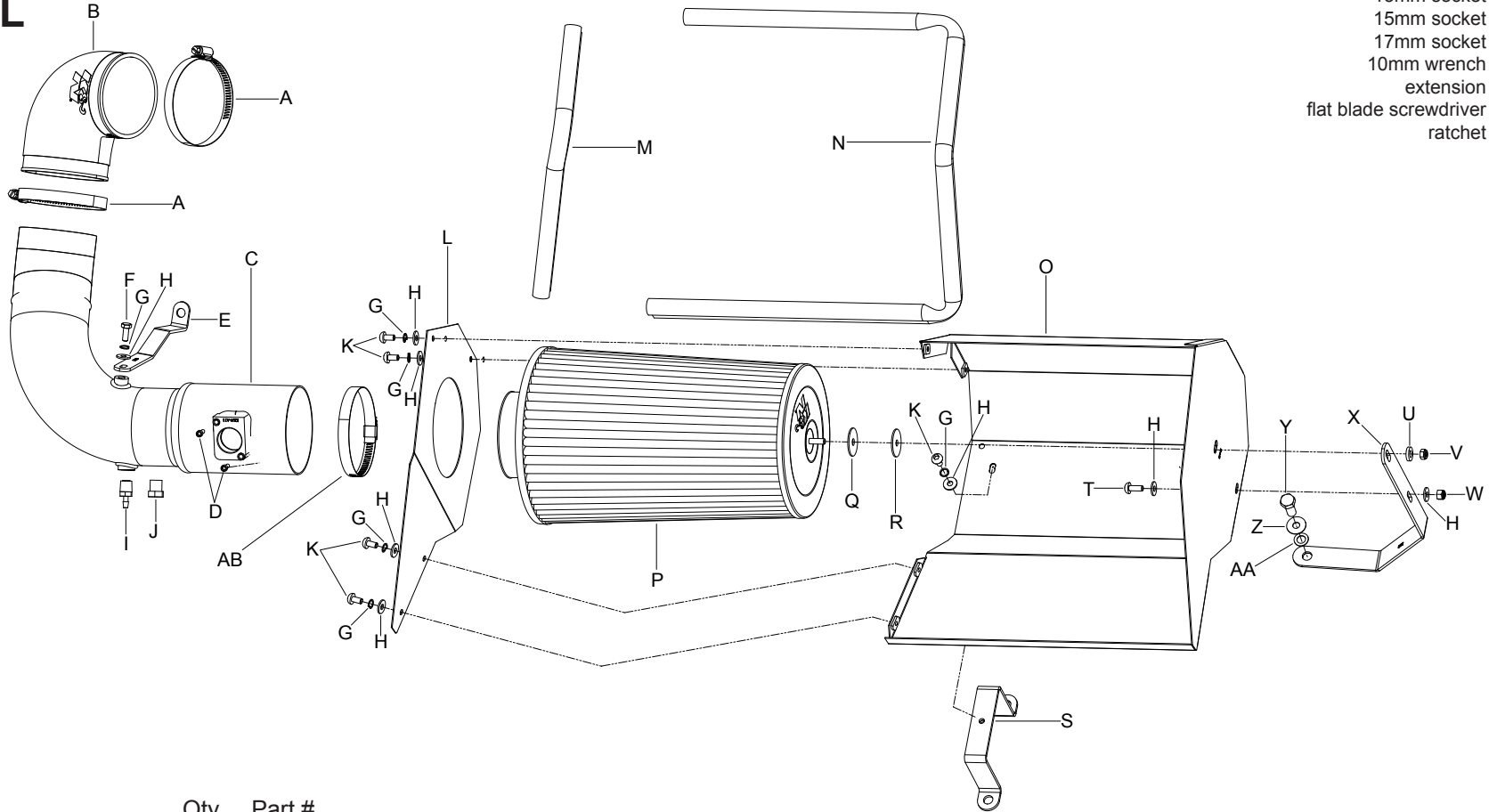

TOOLS NEEDED:

3mm allen wrench
4mm allen wrench
7/16" wrench
9-16" wrench
7mm socket
12mm socket
13mm socket
15mm socket
17mm socket
10mm wrench
extension
flat blade screwdriver
ratchet

PARTS LIST:

Description	Qty.	Part #	Description	Qty.	Part #	Description	Qty.	Part #
A Hose Clamp #56	2	08620	K Bolt; M6 X 1.00" 12mm ButtnHd., SS	5	07794	U Washer; 1/4"ID X 5/8"OD - SAE	1	08275
B Hose; 3-1/2"ID, Angled, Silicone	1	084088	L Heat Shield	1	07642	V Nut; 1/4-20, Nylock, ZN	1	07517
C Intake Tube	1	27558	M Edge Trim 14"	1	102475	W Nut; 6mm, HexHd.	1	07553
D Bolt; M4 - 0.07 8mm, A/H Cap, SS	2	07733	N Edge Trim 44"	1	102486	X Bracket; "L", Stl., FB/PC	1	26643
E Bracket; "L", Stl. FB/PC	1	26650	O Heat Shield	1	07643	Y Bolt; M10-1.5 X 25mm Hexhd.	1	07702
F Bolt; 6mm-1.00 X 16mm, SS	1	07812	P Air Filter	1	RC-5181	Z Washer; 10mm Wave	1	08175
G Washer; 1/4" Lock, ZN	6	08198	Q Washer; 1.25 X .30 X .10 Rubber	1	21708	AA Washer; 3/8" Flat, SS	1	08134
H Washer; 6mm Flat, SS	8	08269	R Washer; 1.25D X .28	1	08151	AB Hose Clamp #72	1	08671
I Vent; Strt., 3/16 Barbed 1/4"NPT, Nylon	1	080021	S Bracket; "C", Stl., FB/PC	1	26644			
J Plug; 1/4 NPT, Plastic	1	08032	T Bolt; M6 X 1.00 X 16mm, Buttonhead, SS	1	07730			

NOTE: FAILURE TO FOLLOW INSTALLATION INSTRUCTIONS AND NOT USING THE PROVIDED HARDWARE MAY DAMAGE THE INTAKE TUBE, THROTTLE BODY AND ENGINE.

TO START:

1. Turn off the ignition and disconnect the negative battery cable.

NOTE: Disconnecting the negative battery cable erases pre-programmed electronic memories. Write down all memory settings before disconnecting the negative battery cable. Some radios will require an anti-theft code to be entered after the battery is reconnected. The anti-theft code is typically supplied with your owner's manual. In the event your vehicles' anti-theft code cannot be recovered, contact an authorized dealership to obtain your vehicles anti-theft code.

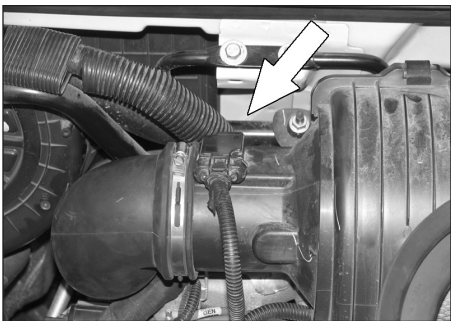

2. Release the locking tab and then disconnect the mass air sensor electrical connection.

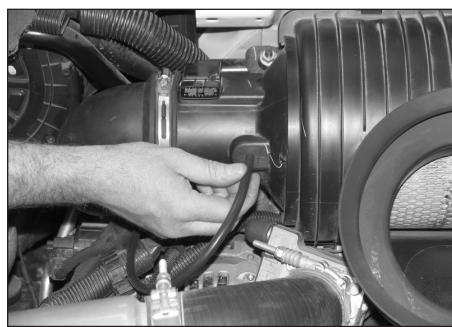

3. On vehicles equipped with a filter minder, disconnect the filter minder vacuum hose from the stock filter housing.

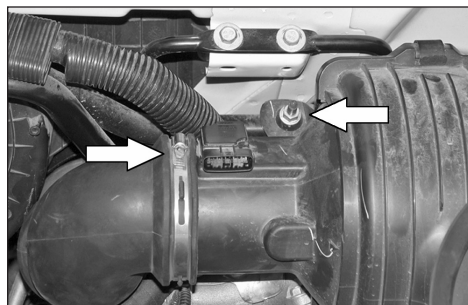

4. Loosen the hose clamp that secures the stock intake tube to the filter housing and then remove the nut that secures the filter housing to the support bracket.



5. Remove the bolt that secures the filter housing to the support brace shown.



6. Remove the filter housing assembly from the vehicle.



7. Loosen the hose clamp that secures the intake tube assembly to the turbo inlet tube. Then remove the complete inlet tube assembly from the vehicle as shown.

NOTE: K&N Engineering, Inc., recommends that customers do not discard factory air intake.



8. Remove the two screws that secure the mass air sensor to the stock filter housing and then remove the mass air sensor assembly.

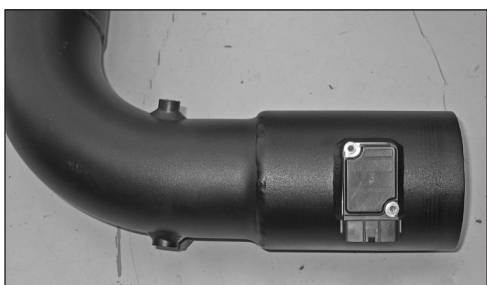

9. Install the mass air sensor into the K&N® intake tube and secure with the provided hardware.

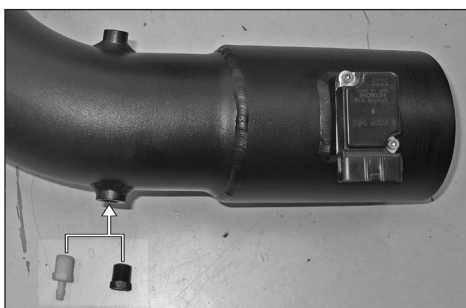

10. On vehicles equipped with a filter minder, install the 1/4" npt vacuum fitting into the K&N® intake tube. On vehicles not equipped with a filter minder, install the 1/4" npt plug into the K&N® intake tube.

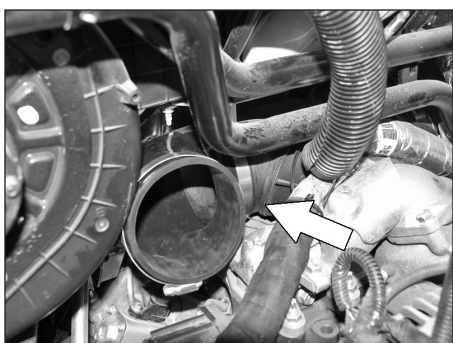

11. Install the 90° silicone hose (084088) onto the turbo inlet and secure with the provided hose clamp. **NOTE: The K&N® logo should be installed towards the turbo inlet. Do not completely tighten at this time.**

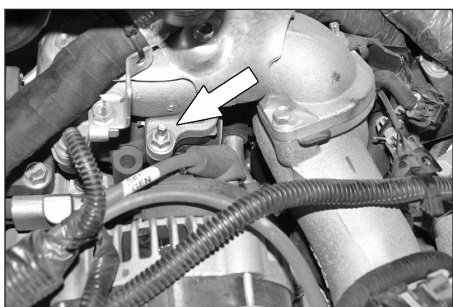

12. Remove the nut from the intercooler manifold mounting stud shown. **NOTE: This nut will be reused in the next step.**

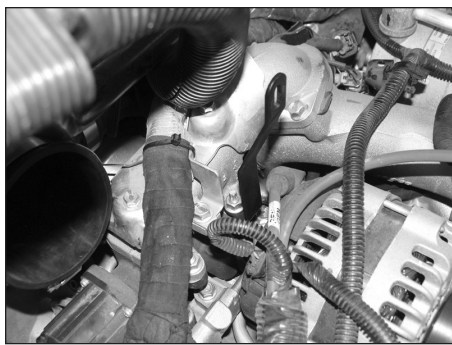

13. Install the tube mounting bracket (26650) onto the intercooler mounting stud and secure with the nut removed in step #12.

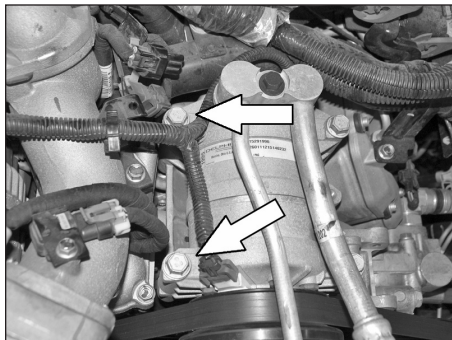

14. Remove the two A/C compressor pump mounting bolts shown.

NOTE: These bolts will be reused in the next step.

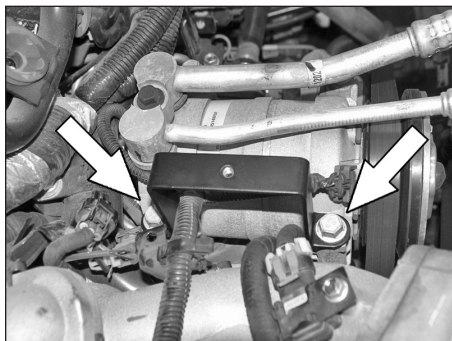

15. Install the heat shield mounting bracket (26644) onto the A/C compressor and secure with the factory bolts removed in step #14.

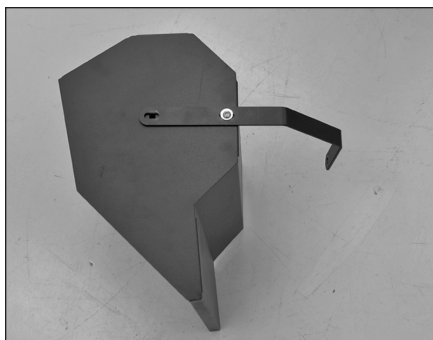

16. Install the heat shield mounting bracket onto the heat shield as shown and secure with the provided hardware.

NOTE: The mounting bolt should be installed through the heat shield from the inside and then through the mounting bracket.



17. Install the long edge trim onto the heat shield as shown.

NOTE: Some trimming of the edge trim may be necessary.

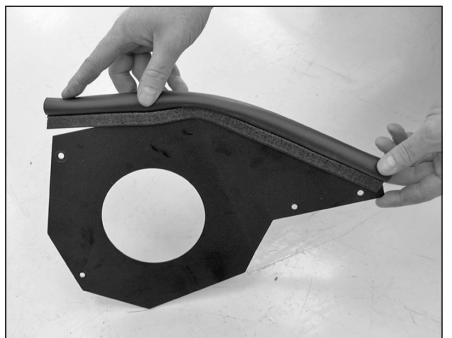

18. Install the small edge trim onto the heat shield wall as shown.

NOTE: Some trimming of the edge trim may be necessary.

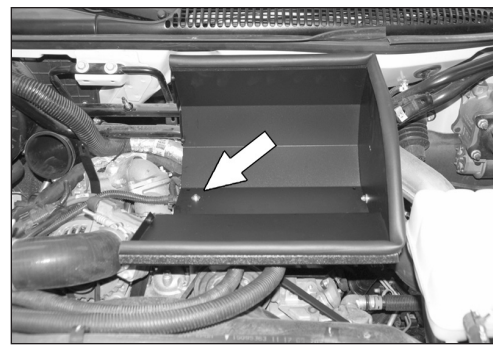

19. Install the heat shield onto the mounting bracket on the A/C compressor and secure with the supplied hardware.

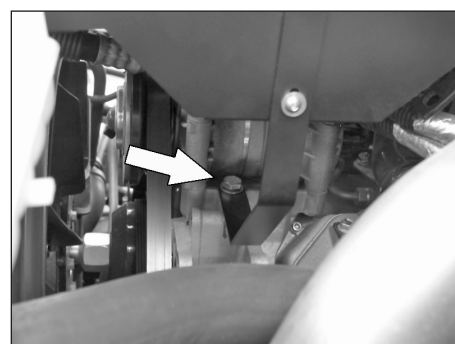

20. Secure the heat shield side bracket to the forward threaded hole next to the A/C compressor as shown with the provided hardware.



21. Install the supplied rubber washer and fender washer onto the stud protruding from the filter lid as shown.



22. Install the K&N® air filter into the heat shield so the mounting stud protrudes through the heat shield and the mounting bracket. Then secure the filter with the supplied hardware.



23. Install the heat shield side panel onto the main heat shield and secure with the provided hardware.

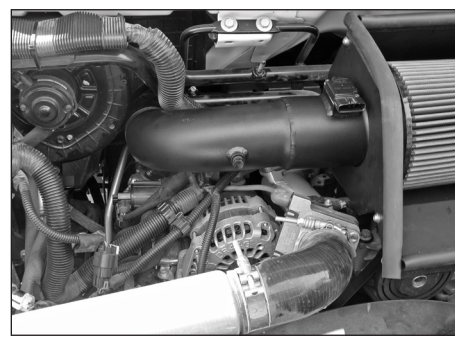

24. Install the K&N® intake tube into the silicone hose and into the K&N® air filter, align the tube with the mounting bracket installed in step #13. Secure the intake tube to the filter and silicone hose with the provided hose clamps and to the mounting bracket with the provided hardware.

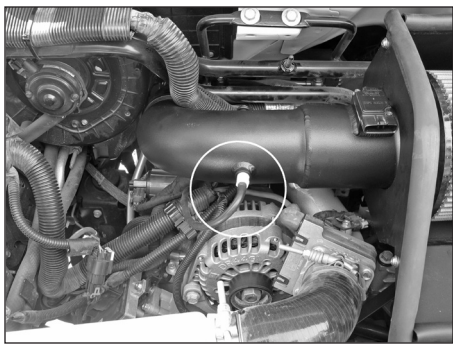

25. On vehicles equipped with a filter minder, connect the vacuum line to the 1/4"npt fitting installed in the K&N® intake tube as shown.



26. Reconnect the mass air sensor electrical connection.



27. Reconnect the vehicle's negative battery cable. Double check to make sure everything is tight and properly positioned before starting the vehicle.

28. The C.A.R.B. exemption sticker, (attached), must be visible under the hood so that an emissions inspector can see it when the vehicle is required to be tested for emissions. California requires testing every two years, other states may vary.

29. It will be necessary for all K&N® high flow intake systems to be checked periodically for realignment, clearance and tightening of all connections. Failure to follow the above instructions or proper maintenance may void warranty.

ROAD TESTING:

1. Start the engine with the transmission in neutral or park, and the parking brake engaged. Listen for air leaks or odd noises. For air leaks secure hoses and connections. For odd noises, find cause and repair before proceeding. This kit will function identically to the factory system except for being louder and much more responsive.

2. Test drive the vehicle. Listen for odd noises or rattles and fix as necessary.

3. If road test is fine, you can now enjoy the added power and performance from your kit.

4. K&N Engineering, Inc., suggests checking the air filter element periodically for excessive dirt build-up. When the element becomes covered in dirt (or once a year), service it according to the instructions on the Recharger® service kit, part number 99-5050 or 99-5000.

INTAKE SYSTEMS FOR VEHICLES LISTED ARE 50 STATE LEGAL. SEE KNFILTERS.COM FOR CARB STATUS ON EACH PART FOR A SPECIFIC VEHICLE.